

# Pressure sensors for general application

with internal diaphragm  
for gauge pressure and absolute pressure

Accuracy 0.25% and 0.5%

Standard output: 4 ... 20 mA; 2-wire  
or 0 ... 5 VDC; 3-wire  
or 0 ... 10 VDC; 3-wire



## Description

Pressure sensors for general application are top of the range pressure transducers.

Their accuracy, reliability, resistance to corrosion and mechanical load make them suitable for all pressure measuring tasks - in production, development or in the laboratory.

The measuring ranges, graded in accordance with EN, range from 25 mbar to the maximum pressure range of 2500 bar. The case and wetted parts comprise stainless steel and are thus resistant to chemically aggressive media. The pressure connection and measuring element are welded together, making the measuring system particularly resistant to mechanical shock or vibration.

For more difficult measuring tasks (e.g. hydrostatic column), two potentiometers enable the zero point and measuring range to be set.

The pressure sensors for general application meet the electronic magnetic compatibility (EMC) requirements to EN 61 326.

## Features

- o Measuring ranges from 25 mbar to 2500 bar
- o Finely graded selection of nominal ranges according to EN
- o Corrosion resistant, stainless steel design
- o High overload protection
- o Highly resistant to shock and vibration
- o For dynamic or static measurements
- o Good reproducibility
- o Simple installation

## Measuring Ranges

Gauge pressure

Negative -1... 0 bar to - 0.025 ...0 bar

Positive 0 ... 0.025 bar to 0 ... 2500 bar

Absolute pressure 0 ... 0.25 bar to 0 ... 16 bar

## Applications

Development and laboratory, process engineering, plant and apparatus construction, hydraulics and pneumatics

## Technical data

Model	P3276						Option
Pressure type	negative or positive gauge pressure			absolute pressure			negative or positive gauge pressure
Output signal	4 ... 20 mA - 2-wire 0 ... 5 VDC - 3-wire 0 ... 10 VDC - 3-wire						0 ... 20 mA; 3-wire other signals on request
Accuracy % of F. S. 1)	0,5 <i>0,25% BFSL</i>	0,25 <i>0,13% BFSL</i>	0,5 <i>0,25% BFSL</i>	0,25 <i>0,13% BFSL</i>	0,5 <i>0,25% BFSL</i>	0,25 <i>0,13% BFSL</i>	
Ranges accord. to EN	0 ... 0.1 bar 2) to 0 ... 25 bar		0 ... 40 bar to 0 ... 2500 bar		0 ... 25 bar to 0 ... 16 bar		0 ... 25 mbar 3) 0 ... 40 mbar 0 ... 60 mbar
Sensor element	piezoresistive		Thin film		piezoresistive		
Repeatability	≤ ± 0.05% of F. S.						
Stability (annual)	≤ ± 0.2% of F. S. in rated conditions						
Case	Stainless steel						
Pressure connection 4)	G 1/2 B to DIN 16 288						G 1/4 B; 1/4 NPT; 1/2 NPT
Wetted parts	Stainless steel 1.4571 and 1.4542						
Overload limit	≤ 16 bar 3,5 x; ≤ 600 bar 2 x; > 600 bar 1.5 x; ≥ 1600 bar 1,2 x						
Electrical connection	plug according to DIN EN 175301-803 form A with junction box round connector M12x1; 4-pin						cable outlet with 1 m cable
Power supply	10 ... 30 VDC (14 ... 30 VDC for output 0 ... 10 V)						
Power consumption	current output 4 ... 20 mA: signal currency current output 0 ... 20 mA: signal currency + 4 mA voltage output: 8 mA						
for output (0) 4 ... 20 mA Load	$\leq \frac{UB - 10V}{0,020A}$ for output 0(4)...20 mA > 5 kOhm for output 0 ... 5 V > 10 kOhm for output 0 ... 10 V						
Temp. compens. range	0 ... 80 °C						
Temperature influence							
- Zero point	± 0.2% / 10 K 5)						
- Measuring range	± 0.2% / 10 K						
Adjustability	zero point and full scale up to ± 10%						
Response time	≤ 1 ms (within 10% to 90% of F. S.)						
Protection type	IP 65 to EN 60 529 / IEC 529 IP 67 to M12x1 connector						IP 67 for cable outlet
Emission 6)	according to EN 61 326						
Interference 6)	according to EN 61 326						
Electrical protection types	polarity, overload and short-circuit protection						
Temperature ranges							
- Storage	-40 ... 100 °C						media temperature
- Medium	-30 ... 100 °C						-40 ... 125 °C
- Ambient	-20 ... 80 °C						
Weight	approx. 0.2 kg						

<sup>1)</sup> Terminal point adjustment according to DIN 16 086, incl. linearity and hysteresis

<sup>2)</sup> 0.25% accuracy for ranges ≥ 0.25 bar

<sup>3)</sup> For ranges < 0.1 bar: model P3275; technical data as model P3276;  
wetted parts 1.4571, Si, Al and Au; only applicable for dry and non aggressive gases

<sup>4)</sup> 0 ... 2500 bar; M 16 x 1.5 female

<sup>5)</sup> ≤ ± 0,4 %/10 K for measuring ranges 0 ... 0.1 and 0 ... 0.16 bar

<sup>6)</sup> Declaration of conformity on request

of F. S. = of full scale value

# Dimensions

## Case

plug according to DIN EN 175301-803 form A with junction box

Accuracy 0.5%

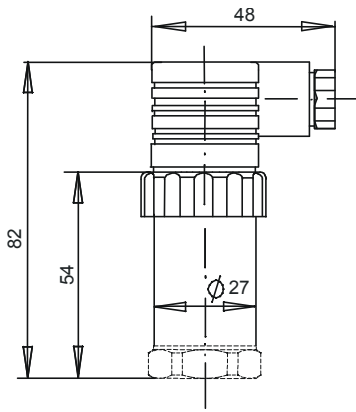

Accuracy 0.25%

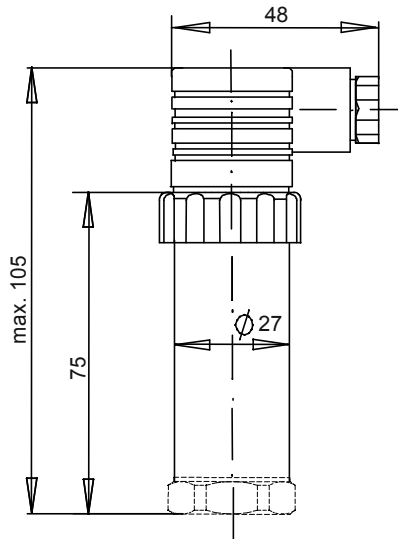

cable outlet

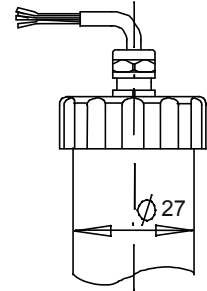

## Pressure connections

G 1/2 B

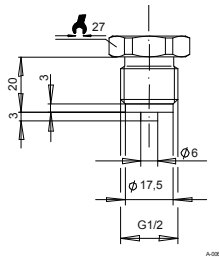

G 1/4 B

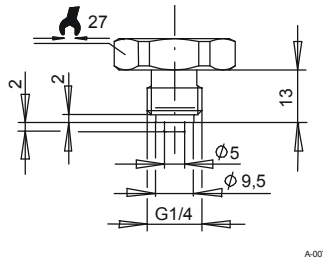

High pressure connection  
M16x1.5 female

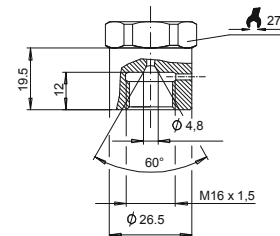

## Screw-in aperture according to DIN 16 288

G 1/2

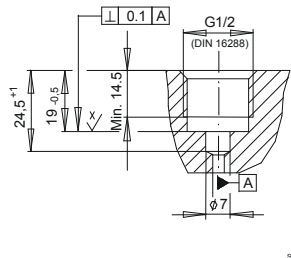

G 1/4

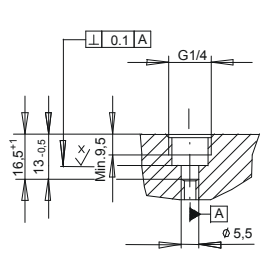

High pressure connection  
M16x1.5 female

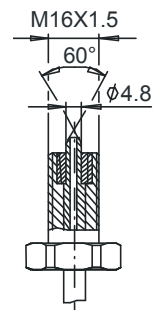

# Electrical connection

## Two-wire system

plug according to DIN EN 175301-803 form A with junction box

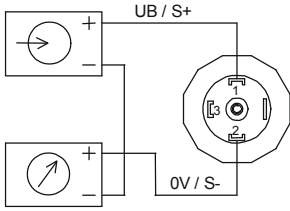

E-001

MIL-plug

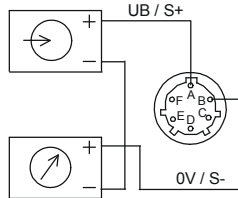

E-011

PT 02 E-10 6P 5-pin plug

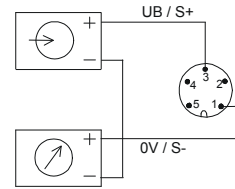

E-035

cable outlet

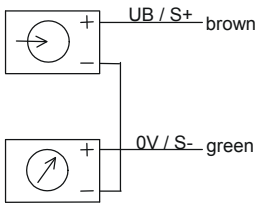

E-015

M12x1

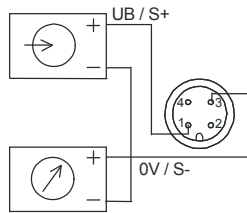

E-033

## Three-wire system

plug according to DIN EN 175301-803 form A with junction box

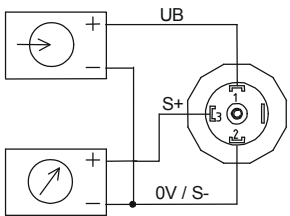

E-002

MIL-plug

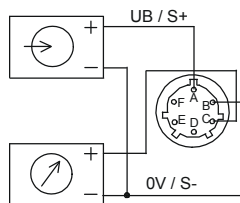

E-012

PT 02 E-10 6P 5-pin plug

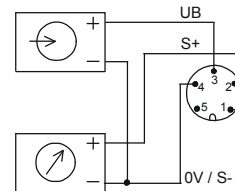

E-036

cable outlet

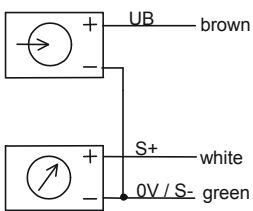

E-017

M12x1

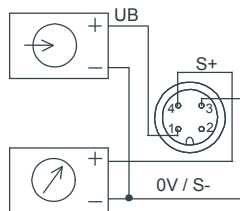

E-034

## Connection table for DIN plug or cable outlet

	4 ... 20 mA (2-wire)		0 ... 10 VDC (3-wire)	
Supply: UB+	1	brown	1	brown
Supply: 0V	2	green	2	green
Signal: S+	---	-----	3	white
Signal:	---	-----	2	green

### Order details

1. Model
2. Measuring range
3. Output signal
4. Options

Modifications reserved